

**OPERATING MANUAL**

**MASTERFLEX® E/S®  
Composite Sampler**



**Model No.**

**07580-00  
and accessories**

A-1299-1015  
Edition 03



**Cole-Parmer**

1-800-MASTERFLEX (627-8373) (U.S. and Canada only) • 11 (847) 549-7600 (Outside U.S.)  
(847) 549-7600 (Local) • www.masterflex.com • techinfo@coleparmer.com

Thermo Fisher Scientific

1-800-637-3739 (U.S. and Canada only) • 11 (847) 381-7050 (Outside U.S.)  
(847) 381-7050 (Local) • www.thermo.com • bar.barnant@thermofisher.com



# TABLE OF CONTENTS

TITLE	Page
<b>SAFETY PRECAUTIONS</b> .....	3
<b>INTRODUCTION</b>	
General.....	4
Suction Lift.....	4
Scope .....	4
<b>SETUP</b>	
Unpacking .....	5
Assembly .....	5
Tubing Selection .....	5
<b>INSTALLATION</b>	
Site Requirements.....	5
Power Requirements .....	5
<b>DESCRIPTION</b>	
Functional Description .....	6
Controls, Indicators and Connectors .....	6
Wetted Parts .....	6
Familiarization with System Features .....	7
<b>INITIAL OPERATION</b>	
System Boot-Internal Battery .....	8
System Boot-External Power.....	9
Battery Charging .....	10
Setting Time and Date .....	10
Security .....	10
Locking the Keypad .....	11
<b>OPERATION</b>	
Description of Programming .....	11
Starting/Stopping a Program.....	11
Cancelling a Program .....	11
Accessing the Menu .....	11
Menu.....	12
Navigation .....	14
<b>GLOBAL SETTINGS</b>	
General.....	14
Global Settings Tour .....	14
<b>VIEW/EDIT PROGRAMS</b>	
General.....	19
Program Menu Tour .....	19
<b>SAMPLING PROGRAM MENU OPTIONS</b>	
General.....	22
Program Start .....	22
Sample Volume .....	23
# of Contact Closures.....	24
Default Program Settings.....	25
Save Program .....	25
Hot Keys.....	26



<b>CALIBRATING THE SYSTEM</b>	
General.....	26
Minimum Sample Size .....	26
Required Equipment .....	26
Calibration Procedure.....	26
Previous Calibrations .....	27
<b>CYCLING THE SYSTEM</b> .....	27
<b>MAINTENANCE</b>	
Cleaning .....	27
Sample Reservoir Vents .....	27
Tubing.....	27
<b>TROUBLESHOOTING</b>	
General.....	28
Error Status/Messages and Solutions .....	28
<b>USER REPLACEMENT PARTS/SERVICING</b>	
Internal Battery Replacement .....	29
<b>USER REPLACEMENT PARTS</b> .....	30
<b>ACCESSORIES</b> .....	30
<b>SPECIFICATIONS</b> .....	31
<b>WARRANTY</b> .....	32
<b>PRODUCT RETURN</b> .....	32
<b>TECHNICAL ASSISTANCE</b> .....	32
<b>ACCESSORY OPERATING INSTRUCTIONS</b>	
07571-50 Automotive Power Adapter .....	33
07571-52 & -54 Auxiliary Power-Pak .....	34
07580-60 Remote Contact Closure Adapter Cable .....	37
07580-65 RS-232 Adapter.....	37

NORPRENE, PHARMED, TYGON—Reg TM Saint-Gobain Performance Plastics Corp.  
 WINDOWS—Reg TM Microsoft Corp.  
 DELRIN, TEFLON - Reg TM E.I. duPont de Nemours & Co.

## SAFETY PRECAUTIONS

**DANGERS:** *NEVER apply AC voltages directly to the EXTERNAL POWER INPUT receptacle on the front panel. The application of AC voltages can result in injury and death of the operator and destruction of the unit. Use only the AC/DC Universal Power Supply/Converter supplied with the unit to power unit from an AC source.*



*NEVER short or connect the terminals of the battery terminals together. Shorting of the battery terminals causes rapid internal heating of the battery resulting in the explosion of the battery and severe injury to or the death of the operator.*

*DO NOT BURN OR INCINERATE THE BATTERY. THE BATTERY MAY EXPLODE CAUSING SEVERE INJURY OR DEATH OF THE PERSONNEL IN THE AREA. (Dispose of the old battery by recycling.)*

**DANGER:** *The AC/DC Universal Power Supply/Converter is rated for INDOOR USE ONLY. DO NOT use the AC/DC Power Supply/Converter in an outdoor environment to either charge the battery or power the drive. Electrical shock, severe injury and/or death are possible if this warning is ignored.*



**CAUTIONS:** *Do not reverse the connections to the battery. If the battery connections are reversed, damage to the unit will occur.*



*Fully charge the unit before using for the first time. Damage to the internal battery can result if the battery is in a fully discharged state and operation of the unit is attempted.*

*Immersion or submersion of the unit will result in improper operation and possible damage to the unit.*

*Use of pump heads, tubing sizes and formulations other than those specified in this manual, or the mounting and use of two or more pump heads concurrently will result in improper operation and possible damage to the unit.*

*If the battery connections are reversed, damage to the unit may occur. The battery terminals are color coded. Connect the black wire to the black terminal, and the red wire to the red terminal.*

**WARNINGS:** *Tubing breakage may result in fluid being sprayed from the pump. Use appropriate measures to protect the operator and equipment.*



*Turn drive off, remove all the power to the unit, including the AC/DC Power Supply/Converter, Automotive Power Adapter or other external power source if present before removing or installing pump head or tubing. This will help prevent accidental activation of the drive mechanism so fingers or loose clothing will not get caught in the pump drive mechanism.*

*PRODUCT USE LIMITATION This product is not designed for, nor intended for use in, patient-connected applications, including, but not limited to, medical and dental use and, accordingly, has not been submitted for FDA approval.*

## **WARNING: PRODUCT USE LIMITATION**

*This product is not designed for, nor intended for use in, patient-connected applications, including, but not limited to, medical and dental use and, accordingly, has not been submitted for FDA approval.*

# INTRODUCTION AND GENERAL DESCRIPTION

## GENERAL

The MASTERFLEX® E/S® Composite Sampler is a DSP controlled, portable, self-contained, programmable peristaltic pump system designed to meet EPA, NPDES guidelines for the sampling of storm and waste water.

The MASTERFLEX E/S Composite Sampler as shown in Figure 1, consists of an exterior housing, a controls console which contains the internal power source, pump drive system and system controls, a MASTERFLEX® L/S® EASY-LOAD® peristaltic Pump Head and a sealed and vented sample reservoir. The drive system is capable of operating one MASTERFLEX® L/S® Standard®, L/S® EASY-LOAD® or L/S® PTFE Pump Head.

The MASTERFLEX E/S Composite Sampler is current limited, protected from reverse power supply polarity and transient voltages.

You may operate the MASTERFLEX E/S Composite Sampler on the internal battery, an external 12V DC source or indoors using the 115V AC or 230V AC with the AC/DC Universal Power Supply/Converter supplied with the unit.

The system features a built-in spill-proof gel battery and recharging system allowing the unit to be recharged from an AC power source using the supplied AC/DC Universal Power Supply/Converter or from an automotive 12V DC electrical system if used with the Automotive Power Adapter accessory.

It is designed and programmed to accept, control and power one MASTERFLEX L/S EASY-LOAD, Standard or PTFE Tubing Pump Head for fluid transfer and sampling in the field.

The unit is housed in a high visibility, protective polyethylene housing. The control panel and the drive controls have an environmental protection rating of IP56.

When closed and latched, the drive will float for a minimum of 30 minutes if dropped into a lake or stream to allow recovery of the unit.

## SUCTION LIFT

The MASTERFLEX E/S Composite Sampler is capable of lifting a sample of water up to twenty-five (25) feet vertically. This capability is called suction lift and is measured from the surface of the liquid to the Pump Head.

If the liquid to be sampled has a viscosity or density greater than water, this lifting capability is reduced or diminished. This lifting capability is also diminished as altitude above sea level increases.

## SCOPE OF THE MANUAL

This manual contains instructions for installing, setting up, programming, operating and maintaining the sampling system. It is intended for use by technicians and operators as well as maintenance personnel. The TROUBLESHOOTING section contains a list of possible problems, their probable causes, and actions to take to remedy each problem.

Instructions for replacing user-serviceable parts and a list of parts that can be ordered are included.

The ACCESSORIES section lists all available accessories for the MASTERFLEX E/S Composite Sampler.

FIGURE 1

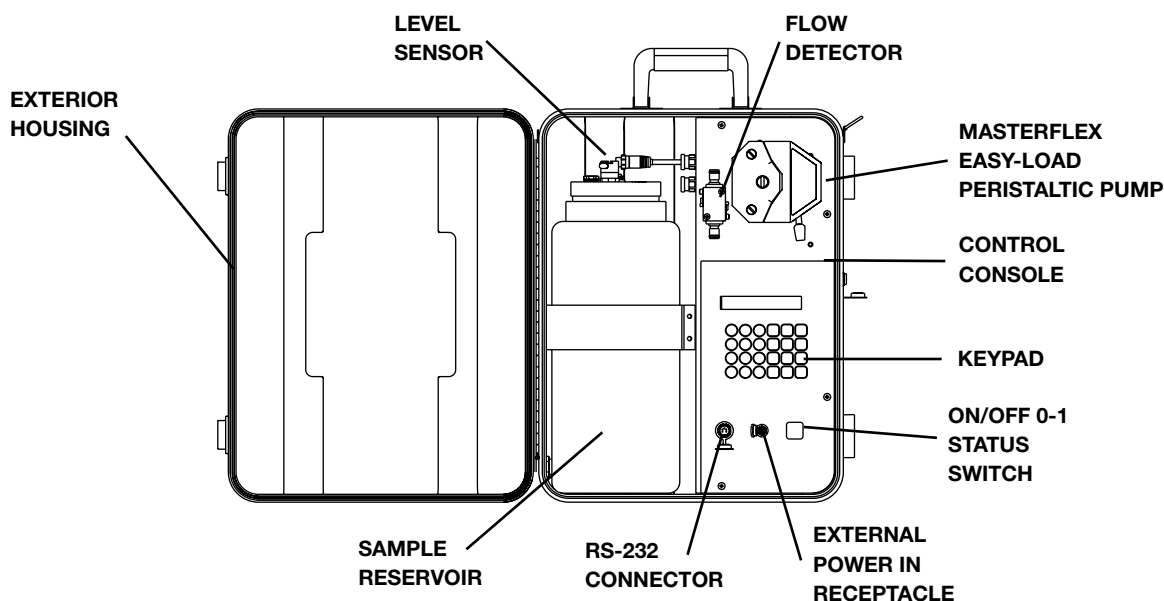

## SETUP

### UNPACKING

Care has been taken in the packaging of the MASTERFLEX E/S Composite Sampler to protect it in transit to its final destination. After opening the carton, save the packing material until proper product operation has been verified.

The MASTERFLEX E/S Composite Sampler consists of the following items:

- (1) Sampling Unit
- (1) AC/DC Universal Power Supply/Converter
- (1) Sample Line Tubing Connector
- (2) Keys for the locking latches
- (1) 25 feet of MASTERFLEX L/S® 24 size peroxide-cured silicone tubing
- (1) Operator's Manual CD
- (1) Warranty Card

### ASSEMBLING

Unit is shipped fully assembled and plumbed with MASTERFLEX L/S 24 size silicone peroxide-cured tubing. The operator only needs to connect an external sample line using the supplied tubing connector into Sample Line Inlet bulkhead connector shown in Figure 2.

### TUBING SELECTION

The flow rate at which a sample can be taken is dependent on the tubing size, tubing material and the height the sample must be raised to enter the sample reservoir. The purity of the sample is dependent on the formulation of the tubing material. The Composite Sampler is supplied with L/S® 24 size tubing made of peroxide-cured silicone resins. The tubing supplied with the unit has been selected based on its purity versus flow and lift performance. Optimum lift and flow performance can be had by using TYGON® LFL® or Lab tubing.

See Table 1 for other tubing materials and sizes available for operation with the Composite Sampler.

**TABLE 1 Tubing Materials**

Tubing formulation	L/S® 15	L/S® 24
Silicone, peroxide-cured	96400-15	96400-4
TYGON, Lab®	06409-15	06409-24
TYGON LFL®	06429-15	06429-24
PHARMED® BPT	06485-15	06485-24



## INSTALLATION

### SITE REQUIREMENTS

The E/S Composite Sampler is designed to operate in most outdoor conditions. Ensure that the work area temperature range is between 1°C to 50°C (34°F to 122°F) and that the relative humidity remains between 10% and 90%.

Position the sampler in an upright position with the carrying handle at the top of the case (as shown), preferably on a firm level surface, adjacent to the source to be sampled. The sampler may also be suspended or attached to a vertical support using the D-rings at the top of the exterior housing.

### POWER REQUIREMENTS

The MASTERFLEX Composite Sampler is internally powered by a 12V sealed gel battery. The unit may also be operated or charged in an outdoor environment using the Automotive Power Adapter Accessory 07571-50, Auxiliary Power Pack 07571-52 or 07571-54, or any DC source supplying 11-18 volts.

Sampler can be operated or charged indoors from a 115 (90-130) V AC or 230 (180-260) V AC 50/60 Hz incoming power using the AC/DC Universal Power Supply/Converter (supplied).

#### **DANGER:**



**NEVER apply AC voltages directly to the EXTERNAL POWER INPUT receptacle on the front panel. The application of AC voltages can result in injury and death of the operator and destruction of the unit. Use only the AC/DC Universal Power Supply/ Converter supplied with the unit to power unit from an indoor AC source.**

#### **CAUTION**



**Fully charge the unit before using for the first time. Damage to the internal battery can result if the battery is fully discharged and operation of the unit is attempted.**

# DESCRIPTION

## FUNCTIONAL DESCRIPTION

The control console of the Composite Sampler provides the operator interface for programming, control and charging of the sampling system. The DSP in the control console scans the keypad, communicates to the display, communicates with the integral pump drive, assesses the state of and controls charging of the battery.

The system is preprogrammed with one (1) fluid transfer program and five (5) sampling programs. All of the factory-supplied sampling programs can be modified by the operator and saved without modifying or destroying the factory supplied programming. The factory supplied programming and operational parameters are stored in non-volatile flash memory within the DSP controller.

Program options and instructions from the operator are stored in non-volatile memory consisting of an EEPROM which supplements the flash memory of the DSP.

## CONTROLS, INDICATORS AND CONNECTORS

All the controls, connectors, and indicators on the controls console and exterior housing are shown in Figure 2 and 3. Table 2 lists all of the operator controls and indicators.

## WETTED PARTS

All parts in direct contact with the sample being taken are considered wetted parts. The following is a listing of the wetted parts and their associated materials.

Sample intake tubing: Unit is supplied with ¼" ID 25 feet of MASTERFLEX L/S® 24 size peroxide-cured silicone tubing.

Sample intake tubing connectors: DELRIN® acetal co-polymer

Tubing: MASTERFLEX L/S® 24 size peroxide-cured Silicone tubing.

Flow detector: PVC and stainless steel

Flow detector tubing connectors: polycarbonate and VITON

Discharge tubing: MASTERFLEX L/S 24 size peroxide-cured silicone tubing.

Discharge tubing fittings: DELRIN acetal co-polymer

Sample reservoir: HDPE (high density polyethylene)

Sample reservoir cap: polypropylene

Breather vents, sample reservoir: medical grade ABS/TEFLON®



FIGURE 2

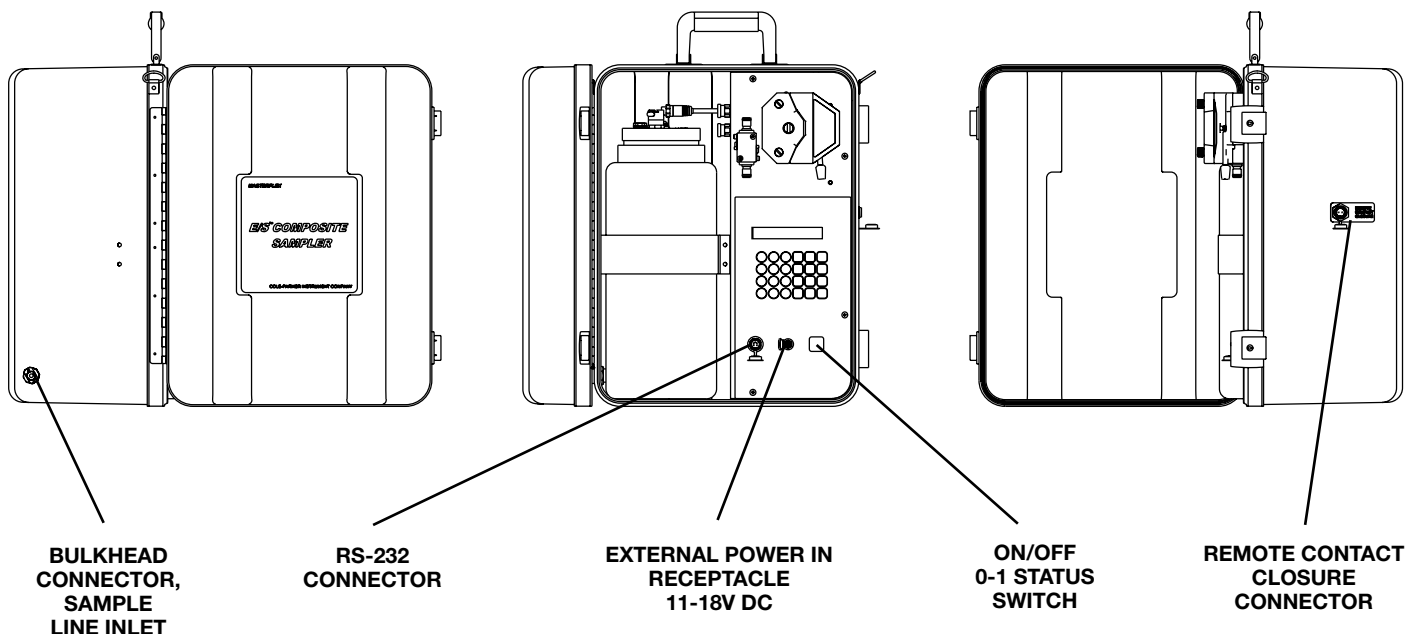

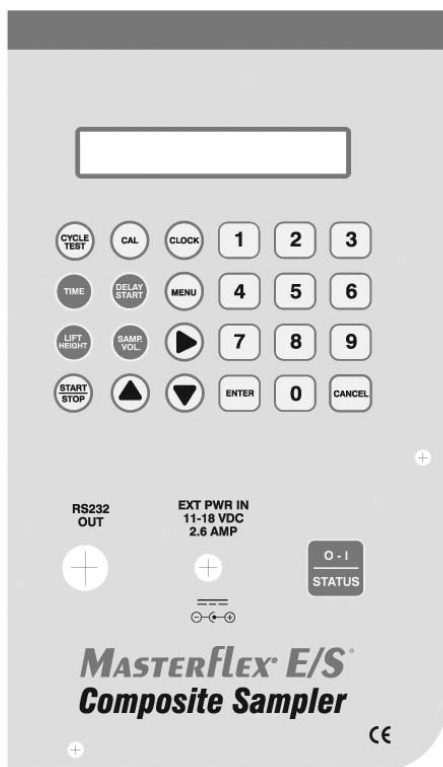

FIGURE 3

## FAMILIARIZATION WITH SYSTEM FEATURES

The system has unique features with which the operator needs to become familiar during the course of system operation. Understanding the features will enable the operator to know if the system is operating properly and effectively. These features are as follows:

**1. Automatic Power-Up:** Any time an external power source is connected to the EXT POWER IN receptacle located on the front of the control console, the system will power up and go through a boot up routine or display a system message as to system status. If no action is taken, the system will charge the battery.

**2. Automatic Power Conservation:** If the system is not implementing an internal command or the operator has not pressed a key on the control console for 10 minutes the system, to conserve power, will POWER DOWN. The LCD display will display a message for 5 seconds:

**POWERING DOWN**

TABLE 2 Operator Controls and Indicators

Control or indicator	Description and function
0-1/ STATUS	Use to turn the unit ON, OFF, check unit status or awaken unit from an inactive mode.
DISPLAY	24 character by two-line LCD that displays all menus needed for programming and operating the system.
MENU	Use to access the menu.
Selection arrow keys	Use to navigate menu options shown on the display.
Numeric keypad 0-9	Use for numeric entry.
START/STOP	Use to initiate program or to stop a program which is running.
CANCEL	Cancels any changes that were made to the current menu selection and returns to previous menu.
ENTER	Accepts the selected item and moves down to the next menu level. If there is not a lower menu level, it will return to the top level for the selected item.
CLOCK	Used to set date and time. The date is displayed in a MM:DD:YY format. The time format is a 24-hour clock displayed in a HH:MM:SS.
TIME	Used to access the time settings in the loaded program.
SAMP. VOL	Used to access the sample volume parameter in the loaded program without going through the menu.
LIFT HEIGHT	Used to access the lift height parameter in the loaded program without going through the menu.
CYCLE TEST	Used to verify unit operation in the field.
CAL	Used to verify and calibrate unit in the field for accurate sample delivery.

After which the display will blank. If an external power source is connected at the time, the battery will continue to charge while the display is blank. If a sampling program was running or in process at the time of power down the system will continue to run the program. The display panel will show a message when the unit starts to take a sample and show the time until the next sample is to be taken. The display will remain active for an additional 5-10 seconds before returning to a powered down state.

If the display panel is not active, press the 0-1/STATUS key on the control console to awaken the system.

**3. Automatic Battery Charging:** System will automatically charge the internal battery any time an external power source such as the AC/DC Universal Power Supply/Converter or Automotive Power Adapter is plugged into the EXT PWR IN receptacle. The rate at which the internal battery is charged will vary with other system operations. Once the battery is fully charged, the integral battery charging circuit will place the battery on a floating or maintenance charge to maintain the battery in a fully charged state.

**4. Automatic Purging:** The system will automatically purge the sample intake line prior to the taking of any sample or the occurrence of a rinse cycle. This is to ensure that the sample inlet line is free of any obstructions or debris.

**5. Glow-In-Dark Keypad:** The keypad is printed with phosphorescent pigments. These pigments will glow for up to 20 minutes if exposed to ultraviolet radiation from the sun or a krypton flashlight. This feature is helpful in low ambient light conditions. The LCD display is backlightable and when used with keys that glow in the dark, this lessens the need for external lighting in dim and dark areas.

## INITIAL OPERATION

### SYSTEM BOOT – INTERNAL BATTERY

Press the 0-1/STATUS button on the control console. The LCD display will activate and display the following messages:

**SAMPLER ON VERSION X.X**

**CHECKING BATTERY  
PRESS CANCEL TO QUIT**

System will power up the drive system to place the internal battery under load and verify its condition.

The LCD panel will display one of the following messages, depending upon battery condition.

**BATTERY FULLY CHARGED**

**BATTERY IS LOW  
CHARGING IS RECOMMENDED**

If the battery is fully charged or you pressed cancel when notified the battery is low, the system will complete boot-up and display the following on the LCD screen:

**SAMPLER SYSTEM READY  
HH:MM:SS MM/DD/YYYY**

If the message displayed is:

**BATTERY IS VERY LOW  
MUST CHARGE BATTERY!**

The system should not be operated until the battery has been charged or an external power source has been connected to the unit. Proceed to the BATTERY CHARGING section of the manual on page 10.

## **SYSTEM BOOT— EXTERNAL POWER**

Open the exterior housing, connect the AC/DC Universal Power Supply/Converter into the EXT PWR IN receptacle on the front. Then connect the AC plug into an AC receptacle. The system will come on automatically. The first screen displayed on the LCD panel will be:

**SAMPLER ON VERSION X.X**

This will be followed by another screen:

**REMOVE EXT PWR TO CHECK  
BATTERY—CANCEL TO SKIP**

Remove the plug from the EXT PWR IN receptacle on the control console. LCD will change to read:

**CHECKING BATTERY  
PRESS CANCEL TO QUIT**

The system will power up the drive system to place the internal battery under load and verify its condition. After the drive system has stopped, you may reconnect the external power to the EXT PWR IN receptacle. The LCD panel will display one of the following messages, depending upon battery condition.

**BATTERY IS FULLY CHARGED**

**BATTERY IS LOW  
CHARGING IS RECOMMENDED**

If the battery is fully charged or you pressed cancel when notified the battery is low, the system will complete boot up and display the following on the LCD screen:

**SAMPLER SYSTEM READY  
HH:MM:SS MM/DD/YYYY**

If the message displayed is:

**BATTERY IS VERY LOW  
MUST CHARGE BATTERY!**

The system should not be operated until the battery has been charged. Proceed to the BATTERY CHARGING section of the manual on page 10.

## BATTERY CHARGING

The Composite Sampler is equipped with an internal four state battery charger capable of diagnosing and automatically charging the internal battery. The operator only needs to connect the AC/DC Universal Power Supply/Converter or Automotive Power Adapter accessory. The sampler system will automatically power up and begin charging the battery. After 10 minutes the LCD display on the control console will power down, going blank. The battery will continue to charge until it has reached is full potential. Once the battery is fully charged, the battery will be placed on a float or maintenance charge until the external power source is disconnected.

The system may run or be programmed while the unit is charging. Battery charging will continue in the background while other operations are taking place. Allow a minimum of 8 hours to fully charge the battery from a fully discharged state with no other operations occurring. During battery charging all functions of the sampler are operational.

**DANGER!**



***The AC/DC Universal Power Supply/ Converter is rated for INDOOR USE ONLY. DO NOT use the AC/DC Power Supply/Converter in an outdoor environment to either charge the battery or power the drive. Electrical shock, severe injury and/or death are possible if this warning is ignored.***

## SETTING THE TIME AND DATE

Press the keypad's CLOCK key. The display will read:

**SET TIME (HR:MIN:SEC)**  
**20:30:57 (23:59:59)**

### TIME

The clock used in the Composite Sampler is a 24-hour clock, does not use an AM or PM notation and shows the time in an HH:MM:SS format. The clock displays 12:00 AM midnight as 00:00:00 (the starting point of the clock), 6:00:00 AM as 06:00:00, 12:00:00 PM (or noon) as 12:00:00 and 6:00 PM as 18:00:00.

If a sample was taken at 3:00 PM the clock will read 15:00:00.

The Composite Sampler clock was set at the factory based upon our local time. The time is expressed as hour, hour, minute, minute, second, second. If the current time on the

clock is correct, bypass setting the time by pressing ENTER or CANCEL and you will be taken to the screen where you may change the date. See the screen below.

If you need to correct the time shown on the clock, use the numeric keypad to enter the current time and press ENTER. The display will change to the date correction screen as shown below.

**SET DATE (MON/DAY/YR)**  
**09/21/02 (MM/DD/YY)**

### DATE

The calendar date is expressed as month, month, day, day, year, year.

If the date is correct, press ENTER or CANCEL and you will be taken back to the system prompt.

If you need to correct the date shown, use the numeric keypad, enter the date and press ENTER.

**EXAMPLE:** To enter January 1, 2003, press 10103 on the numeric keypad and press ENTER.

To enter December 31, 2002, press 123102 on the numeric keypad and press ENTER.

You will then be taken back to the system prompt screen which will now display the current time and date.

**SAMPLER SYSTEM READY**  
**HH:MM:SS MM/DD/YYYY**

### SECURITY

The Composite Sampler will be exposed to an outdoor environment in which the operator may or may not be present or in attendance. To protect the unit from tampering by unauthorized individuals the sampler housing may be locked using the two locking latches on the exterior of the housing.

In addition a security feature has been incorporated into the Composite Sampler to lock the keypad.

## LOCKING THE KEYPAD

The Composite Sampler keypad may be locked to ensure that running programs are not inadvertently terminated or to restrict access to the system. The only key which is functional when the keypad lockout is enabled is the 0-1/STATUS key. Pressing this key will not disable or interfere with any program which is running. To lock the keypad, perform the following procedure either from a system prompt or after you have pressed the START/STOP key to start a program. The keypad lockout cannot be enabled or disabled during programming or the editing of a program.

1. Ensure that the control console is in a system ready prompt or a program is running.
2. Enter 847 on the numeric keypad and press ENTER.
3. The following display appears for approximately five seconds. The display reappears anytime a non-numeric key is pressed and the LCD display is active.

**KEYPAD LOCKOUT ENABLED**

4. To unlock the keypad, enter the same code and press ENTER. The following display appears:

**KEYPAD LOCKOUT DISABLED**

## OPERATION

The unit is operated through the use of a menu system and various hot buttons on the keypad located on the control console face. The menus and their options are shown as words and numbers used in everyday oral communications or speech without the need for decryption or an additional legend.

This equipment should **not** be operated on a "learn as you go" basis. Make sure to become familiar with and practice all safety procedures presented in the SAFETY section before operating the Composite Sampler.

## DESCRIPTION OF PROGRAMMING

The Composite Sampler can be operated using any of the six (6) factory supplied programs through the menu system.

The five (5) sampling programs can be modified or edited and stored for future use. Editing the factory supplied programs and saving them as modified programs will temporarily overwrite the factory program. The factory programs can be individually restored to their original default settings upon operator demand through the menu system.

**NOTE:** One program is always present or selected to run whenever the unit is on. When received from the factory the default program selected to be run is PROGRAM #1.

## STARTING/STOPPING A PROGRAM

To start or stop a program press the START/STOP key. Programs can only be started from a SAMPLER SYSTEM READY prompt. Sampling programs can be stopped at any time the display is active by pressing CANCEL. If the display is inactive, press the 0-1/STATUS key to awaken the system and then press CANCEL. The CONTINUOUS PUMPING program can be stopped at any time. Stopping a program is equivalent to canceling the program. Programs that have been stopped cannot be restarted from the point at which they were stopped. When you start the program again, it will begin at the beginning of the program.

**HINT:** If the program you stopped was taking a sample, it may be necessary to empty or clear the sample reservoir prior to starting the program again.

## CANCELING A PROGRAM

To cancel a program that has started, press the CANCEL key. Canceling a program is the same as stopping a program as described above. Pressing the CANCEL key does not deselect the program selected to be run. It only cancels the program schedule that has started.

**HINT:** The program will show up on the data log as a cancelled program. If you do not want this record to appear on the data log, clear the data log prior to starting the program again.

## ACCESSING THE MENU

Operation of the system and editing programs is menu driven. To access the menu press the MENU button on the control console. The LCD display will show the following.

↓ ■ GLOBAL SETTINGS  
 ↑ □ VIEW/EDIT PROGRAMS

## **MENU**

The menu is divided into two main sections or categories: GLOBAL SETTINGS and VIEW/EDIT PROGRAMS.

### **GLOBAL SETTINGS**

This section consists of operational parameters related to the Composite Sampler system as follows:

- **DISPLAY CONTRAST**
- **SAMPLING LOCATION NUMBER**
- **PUMP HEAD SELECTION**
- **TUBING SIZE SELECTION**
- **TUBING FORMULATION SELECTION**
- **RINSE CYCLES**
- **VOLUME UNITS**
- **DISTANCE UNITS**
- **LIFT HEIGHT**
- **TUBING LENGTH**
- **LCD BACKLIGHTING**
- **DATA LOGGING**
- **DEFAULT GLOBAL SETTINGS**

### **VIEW/EDIT PROGRAMS**

The VIEW/EDIT PROGRAMS section consists of parameters related to the sampling programs as follows:

- **SELECT HOW PROGRAM IS STARTED**
- **SAMPLE VOLUME**
- **NUMBER OF SAMPLES**
- **TIME INTERVAL BETWEEN SAMPLES EQUAL OR UNEQUAL**
- **# OF CONTACT CLOSURES**
- **DEFAULT THE PROGRAM SETTING**
- **SAVE USER PROGRAM**

See Table #3 for menu categories and selections.

**TABLE #3 MENU SELECTIONS**

Defaults are shown in BOLD type or noted

CATEGORY	SELECTION CHOICES	SUB SELECTIONS		
GLOBAL	DISPLAY CONTRAST	UP & DOWN ARROWS TO ADJUST		
	LOCATION NUMBER	ENTER 0-99999999		
	PUMP HEAD	EASY-LOAD/Standard	SIZE 24	TYGON LFL TYGON LAB <b>SILICONE TUBING</b> PHARMED BPT TUBING
			SIZE 15	
		PTFE TUBING PUMP	PTFE 4 MM	
			PTFE 6 MM	
	RINSE CYCLES	ENTER NUMBER 0-5 <b>Default is 0</b>		
	VOLUME UNITS	<b>MILLILITERS</b>		
		GALLONS		
	DISTANCE UNITS	<b>FEET</b>		
		METERS		
	LIFT HEIGHT	ENTER NUMBER <b>Default is 6 feet or 1.8 meters</b>		
	TUBING LENGTH	ENTER NUMBER <b>Default is 12 feet or 3.6 meters</b>		
	LCD BACKLIGHTING	<b>NONE – POWER SAVER</b>		
		BACKLIGHT ON KEY PRESS		
		KEY PRESS AND SAMPLING		
CONTINUOUS BACKLIGHT				
LOG DATA	<b>VIEW LOG DATA</b>			
	PRINT LOG DATA			
	CLEAR LOG DATA	CLEAR ALL LOG DATA		
		<b>DON'T CLEAR LOG DATA</b>		
DEFAULT GLOBAL SETTINGS	RESET GLOBAL SETTINGS			
	<b>DON'T RESET SETTINGS</b>			
VIEW/EDIT PROGRAMS	PROGRAM START	DELAYED START	HHH:MM (0-167.59)	
		REMOTE & DELAYED START	HHH:MM (0-167.59)	
	SAMPLE VOLUME	ENTER NUMBER (1-9, 000)		
		NUMBER OF SAMPLES		
	TIME BETWEEN SAMPLES	EQUAL INTERVALS	HH:MM (0-99:59)	
			HH:MM (0-99:59)	
		UNEQUAL INTERVALS	#1 HH:MM (0-99:59)	
			#2 HH:MM (0-99:59)	
			#3 HH:MM (0-99:59)	
			#4 HH:MM (0-99:59)	
			#5 HH:MM (0-99:59)	
			#6 HH:MM (0-99:59)	
			#7 HH:MM (0-99:59)	
			#8 HH:MM (0-99:59)	
#9 HH:MM (0-99:59)				
#10 HH:MM (0-99:59)				
#11 HH:MM (0-99:59)				
#12 HH:MM (0-99:59)				
# OF CONTACT CLOSURES	ENTER NUMBER (0-9999) <b>Default is 0</b>	Only appears if MAINTAINED is not chosen under PROGRAM START/REMOTE & DELAYED START		
DEFAULT PROGRAM SETTINGS	RESET PROGRAM SETTINGS			
SAVE USER PROGRAM	DON'T RESET SETTINGS			
	USER PROG #1			
	USER PROG #2			
	USER PROG #3			
	USER PROG #4			
USER PROG #5				

## NAVIGATION

Looking at the LCD display screen below:

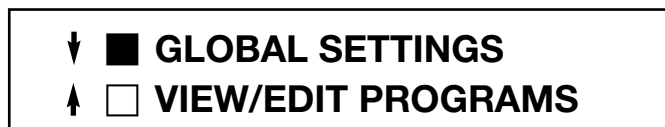

1. The MENU key takes you to the top level of the menu as shown above.
2. The arrows in the first display column indicates which way the user can go from each menu selection.
3. Solid box in second column indicates selected menu item, empty box is an unselected menu item.

**NOTE:** Only one selection is allowed in each menu option.

4. UP/DOWN arrow keys on the control console move the solid box to select a menu item and scroll the display if more menu items are available.
5. The ENTER key accepts the selected item and moves down to the next menu level. If there is not a lower menu level, it will return to the top level for the selected item. For example, if selecting a tubing material, pressing ENTER will return back to the PUMP HEAD menu selection.
6. CANCEL key cancels any changes that were made to the current menu selection and returns to previous menu.
7. CANCEL key will back up to previous menu level and exit the menus when at the top level.
8. Display is 2 lines by 24 characters so only 2 lines of the menu are seen at one time.

## GLOBAL SETTINGS

### GENERAL

The GLOBAL SETTINGS are not saved in memory like multiple sampling programs. The only settings available are those currently loaded into the non-volatile memory.

Selecting a menu option or setting using the up and down arrow keys does not load that option or setting in memory until the ENTER key is pressed.

Settings must be modified as necessary to suit the sampling site and equipment used. Many of these settings may use the default values, such as Pump Head selection, tubing size or formulation. Other parameters such as lift height and tubing length or location will vary with the sampling site and will be changed frequently.

## GLOBAL SETTINGS TOUR

The tour of the GLOBAL SETTINGS menu will take the operator through each of the menu selection display screens. Going through the entire menu is not necessary each time a change to one or two GLOBAL SETTINGS parameters is made. It is recommended that you take the tour to familiarize yourself with all of the options and screens available.

Select GLOBAL SETTINGS by pressing the ENTER key.



The display will now show the following choices:



### Display Contrast

Allows adjustment of the display contrast for readability.

### Adjusting the Display Contrast

To adjust the contrast of the LCD display, select DISPLAY CONTRAST and press the ENTER key. The following menu will be displayed:



View the display and use the up and down arrow keys to adjust the contrast. Press the up arrow key to increase contrast or the down arrow key to decrease contrast. When you have achieved the desired contrast, press the ENTER key. This will save the contrast setting you have selected for the display. The system will return you to the following display.



Use the down arrow to select LOCATION NUMBER, the filled in box will switch from DISPLAY CONTRAST to LOCATION NUMBER and press ENTER. The display will change to read:

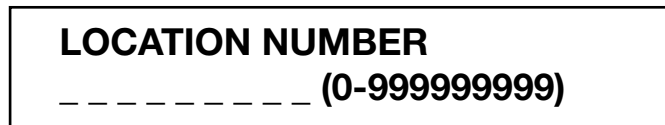

**Location Number**

Allows the input of up to a 9 digit number to identify the sampling site. You do not have to erase or delete the number (site identifier) that may already be there.

**Inputting a Location Number**

Enter the number and press ENTER. The new site identification number will be entered and the display will change to:



Use the down arrow to decrement the menu to and select PUMP HEAD by pressing ENTER.



The display changes to read:



**Pump Head**

Multiple option screens which allow the operator to select the Pump Head, tubing size and tubing formulation or material.

EASY-LOAD is the default Pump Head supplied with the Composite Sampler for your convenience in changing the tubing when needed. If you intend to use the Pump Head supplied with the unit press ENTER.

If you wish to use a PTFE TUBING PUMP proceed to the description of this menu option on page 16.

The display will change to read:

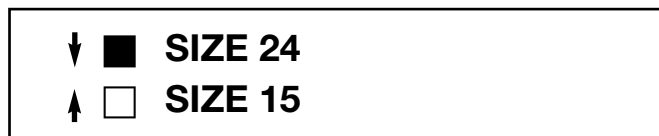

**Size 24** is the default tubing size. The tubing supplied with the Composite Sampler is L/S® 24 peroxide-cured silicone Model No. 96400-24. This tubing size will deliver an average flow of 1,700 ml/min. @ 0 lift.

**Size 15** is an alternate tubing size offered for use with the EASY-LOAD Pump Head supplied with the Composite Sampler. This size option is offered for circumstances where the use of L/S® 24 in certain formulations may not be practical. The average flow of L/S® 15 tubing is 1,000 ml/min. @ 0 lift.

Select the appropriate tubing size and press the ENTER key. The display will change to the tubing formulation menu.

**NOTE:** The display is only 2 lines, so you will only see 2 choices at one time. Remember the arrow in the first column indicates whether there are choices above or below the ones you are viewing.



The tubing formulations shown are available in either SIZE 24 or SIZE 15. See Table 1 Tubing Materials in the SETUP section of this manual for tubing model numbers.

## PTFE Tubing Pump

This Pump Head is offered as an option for those sampling applications such as toxic fluids and oily waste water where only the use of TEFLON tubing will perform adequately for the application.

↓  **EASY-LOAD/STANDARD**  
 ↑  **PTFE TUBING PUMP**

Use the up and down arrow keys to navigate and select the PTFE TUBING PUMP and press ENTER. The display will change to show the tubing sizes available for use with the PTFE TUBING PUMP.

↓  **PTFE 4 MM**  
 ↑  **PTFE 6 MM**

Selection of the tubing formulation for sizes 24 and 15 or the selection of the PTFE tubing sizes will return the display to read:

↓  **PUMP HEAD**  
 ↑  **RINSE CYCLES**

Use the down arrow keys to navigate and select RINSE CYCLES and press ENTER. The display will change to read:

**RINSE CYCLES**  
**0 (0-5)**

## Rinse Cycles

This sets the number of rinses (0-5) that the Composite Sampler will perform prior to the taking of each sample. The default is zero (0). The purpose of the rinse cycle is to remove or rinse away any contaminants or residues in the sample intake lines from a previous sampling site or cycle. The tubing will first be purged of any fluid. Then fluid from the sampling site will be drawn into the sample intake lines until the fluid is detected by the flow sensor. The system will then stop and reverse the drive to expel the fluid. This completes one rinse cycle.

To accept the default setting press either CANCEL or ENTER. To change the number of cycles, enter the number of cycles desired and press ENTER.

The display will change to read:

↑ ↓  **RINSE CYCLES**  
 ↑ ↓  **VOLUME UNITS**

Use the down arrow key to navigate and select VOLUME UNITS and press ENTER. The display will change to read:

↓  **MILLILITERS**  
 ↑  **GALLONS**

## Volume Units

Allows the user to select the units in which the sample will be measured. The default is MILLILITERS. The two options are:

### Millileters

Displays the sample volume from 1-9000 milliliters.

### Gallons

Displays the sample volume from 0.001 to 2.377 gallons.

To accept the default press either CANCEL or ENTER. To change the VOLUME UNITS from MILLILITERS to GALLONS, use the arrow key to navigate and select GALLONS and press ENTER. The display will change to read:

↑ ↓  **VOLUME UNITS**  
 ↑ ↓  **DISTANCE UNITS**

Use the down arrow key to navigate and select DISTANCE UNITS and press ENTER. The display will change to read:

↓  **FEET**  
 ↑  **METERS**

## Distance Units

Allows the user to select English or metric distance measurement units. The default is feet.

The two options are:

### Feet

Displays the VERTICAL LIFT (1-25) and TUBING LENGTH (1-99) in whole feet.

### Meters

Displays the VERTICAL LIFT (0.3-7.6) and TUBING LENGTH (.3 to 30.1) in tenths of a meter.

To accept the default press either CANCEL or ENTER. To change the DISTANCE UNITS from FEET to METERS, use the arrow key to navigate and select METERS and press ENTER. The display will change to read:



Use the down arrow key to navigate and select LIFT HEIGHT and press ENTER. The display will change to read:



### Lift Height

Sets the draw or lift height to which the sample must be lifted to enter the sample reservoir.

This parameter allows the system to accurately calculate the sample volume for each revolution of the Pump Head at a specific height. Sample volume decreases as lift height increases. This parameter will be expressed in feet or meters depending upon your earlier choice of DISTANCE UNITS. The default is 6 feet or 1.8 meters. Enter the number and press enter. The acceptable values will be shown in parenthesis on the 2nd line on the right side of the display.

Once you press enter the display will change to:



Use the down arrow key to navigate and select TUBING LENGTH and press ENTER. The display will change to read:



### Tubing Length

Sets the length of tubing through which the sample volume must be drawn. Setting the tubing length allows the system to calculate the correct amount of time for purging the tubing prior to taking a sample. This parameter will be expressed in feet or meters depending upon your earlier choice of DISTANCE UNITS. The default is 12 feet or 3.6 meters. Enter the number and press enter. The acceptable values will be shown in parentheses on the second line on the right side of the display.

Once you press enter the display will change to:



Use the down arrow key to navigate and select LCD BACKLIGHT and press ENTER. The display will change to read:



**NOTE:** The display is only 2 lines, so you will only see 2 choices at one time. Remember the arrow in the first column indicates whether there are choices above or below the ones you are viewing.



### LCD Backlight

Sets the conditions under which the display is backlit for optimum readability. There are four choices of backlighting.

## NONE – Power Saver

The display will not be backlit under any circumstance. This is the default setting and is used to conserve power. If the LCD display can be read without difficulty in the sampling environment, then this is adequate.

## Backlight on Key Press

The LCD will be backlit for 10 seconds when any key is pressed. After 10 seconds the display will return to its normal unlit state. This setting can be useful during programming since it improves the readability of the display without wasting power and provides backlighting during programming or selecting menu options in low ambient light conditions.

## Key Press and Sampling

The LCD will be backlit for 10 seconds when any key is pressed or whenever a sample is to be taken. Ten (10) seconds after the last key is pressed or after the sampling cycle is completed the display will return to its normal unlit state. This setting can be useful during programming since it improves the readability of the display and allows monitoring of the sampling process in low ambient light conditions. If the Composite Sampler will be left unattended during the sampling process this setting is not recommended.

## Continuous Backlight

The LCD will always be backlit as long as the display is active.

**HINT:** The system's automatic power conservation feature blanks the LCD display if no key has been pressed for 10 minutes.

Blanking of the LCD also occurs 10 seconds after the system has taken a sample or processed an internal instruction while running a program. See the FAMILIARIZATION WITH SYSTEM FEATURES section on page 7.

It is recommended that you experiment with the various backlighting options to determine your preference. You can always return to the menu option by pressing ENTER once you have made your selection and pressed ENTER, because the display will change to read:



Proceeding down the menu, use the down arrow key to navigate and select the next menu option LOG DATA and press ENTER. The display will change to read:



**HINT:** The display is only 2 lines, so you will only see 2 choices at one time. Remember the arrow in the first column indicates whether there are choices above or below the ones you are viewing.



## Log Data

The system logs all events, such as: sample location, cycle date and time, sample volume, and any faults which may occur during the sampling process. The system is capable of logging 300 events. This log is stored in non-volatile memory outside of the DSP. This log may be viewed or printed. Viewing or printing the log does not erase or clear the log from memory. The log may only be erased through the use of the CLEAR LOG DATA menu option.

**NOTE:** Should you forget to clear the logged data, the system will begin to overwrite the oldest data first. This occurs only once the capacity of the non-volatile memory log has been exceeded.

## View Log Data

Allows the user or operator to view the data log. This does not erase or clear the data log.

This is the default option for LOG DATA.

## Print Log Data

Allows the printing of the data log. This menu option requires the use of the RS-232 cable assembly catalog no. 07580-65. See the ACCESSORY section for details. Printing of the data log does not erase or clear the data log.

## Clear Data Log

Allows the operator to clear the data log. This is the only way the data log may be cleared or erased. Once you have selected the menu option and pressed ENTER, you will be taken to a confirmation screen as shown below:



The default selection will not clear the data log. You must use the up arrow to select "CLEAR ALL LOG DATA" and press ENTER. Once the ENTER key has been pressed, the log will be erased and the display will change to read:



Use the down arrow key to navigate and select DEFAULT GLOBAL SETTINGS and press ENTER. The display will change to read:



## Default Global Settings

Allows the operator to return all of the GLOBAL SETTINGS to their default values.

If you have made changes to the GLOBAL SETTINGS and lost track of the changes you have made or would just like to start your changes from some common point, this option will prove to be helpful. This option allows resetting of the GLOBAL SETTINGS without having to track your changes or remember what the default was.

To reset the GLOBAL SETTINGS you must use the up arrow key to navigate and select RESET GLOBAL SETTINGS and press ENTER. This confirmation of your selection to return the settings to their default value is done to prevent accidental or unintended changes to the global settings. Once you press the enter key your previous changes will be lost and cannot be recovered.

**HINT:** To exit the menu and return to a system ready prompt use the cancel key.

## Hot Key

One option of the GLOBAL SETTINGS menu is also accessible via a "Hot Key" located on the control console keypad. The key is round, blue in color and labeled LIFT HEIGHT. This key allows the operator to access the lift height setting in the GLOBAL SETTINGS without going through the menu.

# VIEW/ EDIT PROGRAMS

## GENERAL

There are a total of 6 programs supplied with the Composite Sampler. One program is a fluid transfer program called CONTINUOUS PUMPING, this program cannot be modified. The other 5 programs are fluid sampling programs. These programs are numbered 1 through 5. All programs can be accessed through the menu system of the Composite Sampler. The 5 sampling programs can be edited to create your own sampling programs. Edited or modified programs must be saved before they can be run. Modifying the factory supplied programs and saving them as modified programs will temporarily overwrite the factory program. The factory programs can be individually restored to their original default settings upon demand.

Only (1) one program can be loaded and used at a time. A program is always loaded into memory of the Composite Sampler.

## PROGRAM MENU TOUR

Operation of the system is menu driven. To access the menu, if not presently displayed, press the MENU button on the control console. The LCD display will show the following.

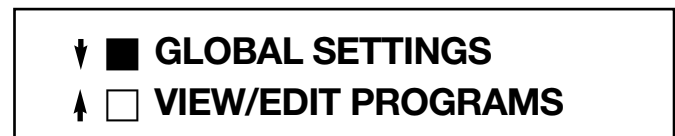

Use the down arrow key to navigate and select VIEW/EDIT PROGRAMS and press ENTER. The display will change to read:

**HINT:** The display is only 2 lines, so you will only see 2 choices at one time. Remember the arrow in the first column indicates whether there are choices above or below the ones you are viewing.

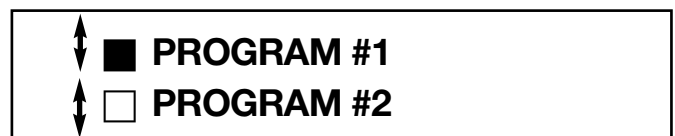

Navigate further into the program options by using the ¼ down arrow key.

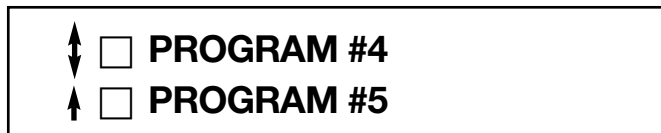
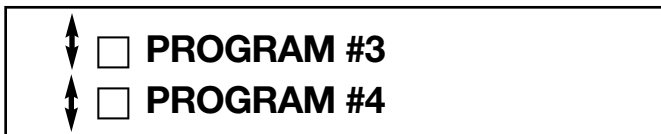
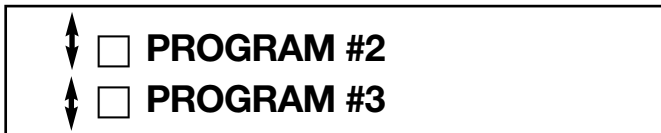

**Loaded Programs**

One of the available programs is always loaded into the memory for use. How do you verify which program is loaded for operation of the Composite Sampler? To verify which program is loaded for operation of the unit, access the menu by pressing the MENU key and selecting VIEW/EDIT PROGRAMS, then press the ENTER key.

The display will change to show 2 program options. One of these options will show a darkened or filled in box next to the program name. This is the program which is loaded for operation.

See the example below.

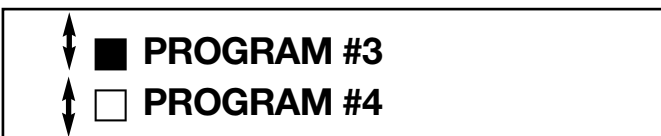

In this case PROGRAM #3 is loaded for operation as shown in the above example.

**Continuous Pumping**

This program is for fluid transfer in the field. The pump will start when the START/STOP button is pressed or the REMOTE CONTACT CLOSURE is closed. The pump will stop when the same button is pressed again, the REMOTE CONTACT CLOSURE opens or the fluid level sensor in the sample reservoir causes the system to stop because the reservoir is full. This program cannot be modified in any manner. This program selection is not visible when you first access the program menu. Select VIEW/EDIT PROGRAMS and press ENTER. The display will change to read as follows.

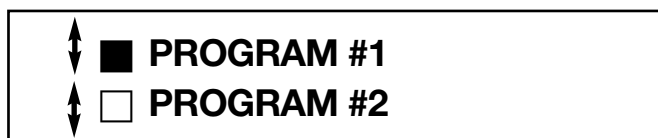

The arrow at the far left of the display on line 1 shows a bi-directional arrow, indicating there is an available option above PROGRAM #1.

Use the up arrow key to navigate upward in the menu. The display will change to read:

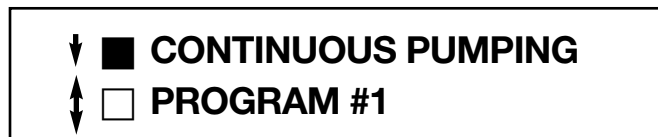

You may now select CONTINUOUS PUMPING by pressing the ENTER key.

**SAMPLING PROGRAMS #1-5**

The attached summary shows the default values for the 5 factory sampling programs

PARAMETER	PROGRAM 1	PROGRAM 2	PROGRAM 3	PROGRAM 4	PROGRAM 5
PROGRAM START					
DELAYED START HR:MIN 0-167:59	00:00			01:00	
REMOTE & DELAYED START		00:00	167:59		01:00
MAINTAINED CONTACT		X			X
PULSED CONTACT			X		
SAMPLE VOLUME 1-9000ml	500	500	375	500	375
NUMBER OF SAMPLES 1-99	18	12	24	18	24
TIME BETWEEN SAMPLES					
EQUAL INTERVALS HH:MM	00:15		00:00	01:00	01:00
UNEQUAL INTERVALS HH:MM		X			
#1		00:15			
#2		00:30			
#3		00:45			
#4		01:00			
#5		01:15			
#6		01:30			
#7		01:45			
#8		02:00			
#9		02:15			
#10		02:30			
#11		02:45			
#12		03:00			
# OF CONTACT CLOSURES	0	Not Visible	5	0	Not Visible

# SAMPLING PROGRAM MENU OPTIONS

## GENERAL

All of the sampling programs have the same menu options. Programs are constructed or built by editing the existing program sampling menu options and saving those changes as a modified program. The sampling menu options are accessed through any of the sampling programs, shown in the VIEW/EDIT PROGRAMS menu. Select a sampling program such as PROGRAM #1 and press the ENTER key. The display will change to read:



**NOTE:** You may make only one selection in each menu option.

Select PROGRAM START and press ENTER. The display will change to read:



## PROGRAM START

Allows the operator to change how the program starts: immediately, with a delay or through the use of another device. There are two options; DELAYED START and REMOTE & DELAYED START.

Select DELAYED START and press ENTER: The display will change to:

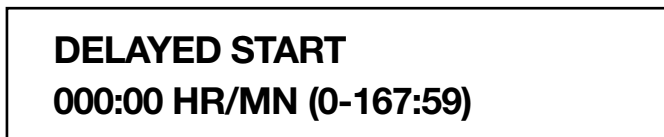

## Delayed Start

Allows the operator to input the time delay for starting the program once the START button is pressed. The parameter is hours and minutes 0-167:59. If you want the program to start immediately upon pressing the START button input 0 and press ENTER. To start after a delay or waiting period input the desired time. If the desired delay time is 40 hours and 0 minutes input 4000 and press enter. If the desired time is 5 minutes of delay time input 5 and press enter.

## Remote & Delayed Start

Allows the operator to start the Composite Sampler through the use of another instrument using the REMOTE CONTACT CLOSURE (see Figure 2) located on the exterior right hand side of the unit. The other instrument must be able to either close or short the contacts (dry contact closure) or generate a pulse. Some of the instruments or devices that may be used to start the Composite Sampler remotely are: level sensors or float switches, pH meters or flowmeters.

Using the remote start component of this feature you can sample a water source upon the occurrence of an event such as a rain storm or increase in water flow or pH.

The delayed start component of this feature allows the operator to add a time delay once the contact closure or remote signal has activated the unit. This feature can be used to delay the start of a sampling program until an event causes the water source being sampled to change. An example of this would be a rainstorm upstream of a water source. It may take 15 minutes before the water from the rainstorm affects the water source you are sampling. You do not want to sample the water source until it is affected by the incoming water. You can use a float or level switch to sense an increase of water level and remotely turn on the Composite Sampler and the time delay to cause the program to wait before taking the first sample to allow the waters to mix. The use of this feature requires the Remote Contact Closure Accessory Model No. 7580-60.

See the ACCESSORY section for details.

When you select REMOTE & DELAYED START and press ENTER, the display changes to:

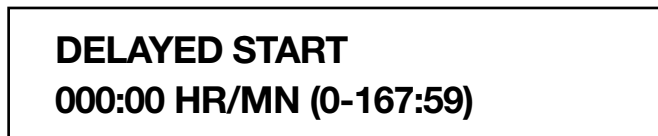

↓  **MAINTAINED CONTACT**  
 ↑  **PULSE CONTACT**

**Maintained Contact**

This is the default type of signal that is continuous or level related. There is continuous continuity between the contacts, like a short. When this option is selected the REMOTE CONTACT CLOSURE must remain closed during the entire sample program. If the REMOTE CONTACT CLOSURE should open during the program; the program will stop after taking the next scheduled sample.

**Pulsed Contact**

This type of signal is not continuous. It goes on and off and the system is able to count the number of pulses or signals to perform various functions.

Select the appropriate type of contact using the arrow keys and press ENTER. The display will return you to:

↓  **PROGRAM START**  
 ↑  **SAMPLE VOLUME**

Use the down arrow key to navigate and select SAMPLE VOLUME and press ENTER. The display will change to read:

**SAMPLE VOLUME**  
**500 ML (1-9000)**

**SAMPLE VOLUME**

Allows the operator to enter the desired sample volume.

Volume units that were selected in the GLOBAL SETTINGS menu option is what will appear. If you selected gallons, then GAL (representing gallons) will appear on the display screen.

The minimum sample volume that can be taken will vary with tubing size. Trying to pump a 1 mL sample with L/S® 24 size tubing is not practical. Use smaller tubing for pumping smaller sample volumes. See the SPECIFICATION section for the minimum volume required for calibration accuracy.

**HINT:** If you will be taking small sample volumes such as 100 mL and or require high lifts greater than 12 feet than you

should consider using L/S® 15 size tubing. This will improve the performance and accuracy of the sample volume taken.

Enter the desired sample volume and press ENTER. The display will return you to:

↓  **PROGRAM START**  
 ↑  **SAMPLE VOLUME**

Use the down arrow key to navigate and select NUMBER OF SAMPLES and press ENTER. The display will change to read:

↕  **SAMPLE VOLUME**  
 ↕  **NUMBER OF SAMPLES**

**Number of Samples**

Allows the operator to set the number of samples to be taken. Select NUMBER OF SAMPLES and press ENTER. The display will change to read:

**NUMBER OF SAMPLES**  
**XX (1-99)**

**HINT:** If the number of samples times the sample volume exceeds the reservoir capacity you will receive an error message asking you to decrease one or the other when you try to save the program. You must correct the problem before you can save the program.

After entering the NUMBER OF SAMPLES press ENTER. The display will return you to:

↕  **SAMPLE VOLUME**  
 ↕  **NUMBER OF SAMPLES**

Use the down arrow key to navigate and select TIME BETWEEN SAMPLES and press ENTER.

↕  **NUMBER OF SAMPLES**  
 ↕  **TIME BETWEEN SAMPLES**

### Time Between Samples

Allows the operator to input the desired time between samples. When TIME BETWEEN SAMPLES is selected and you press ENTER two choices will be presented for your selection.



### Equal Intervals

Allows the operator to input the desired time between samples in an hours:minutes format. All time intervals will be the same or equal. You can select any time period between 0 minute to 99 hours 59 minutes. The time for this option should be set to a value greater than 0 except for applications where the number the # CONTACT CLOSURES is chosen to control time between samples. The display appears as follows:

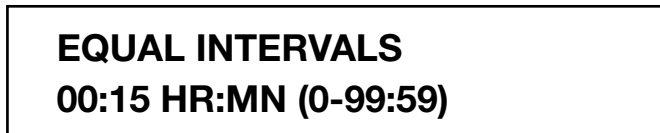

**NOTE:** If you are using the # CONTACT CLOSURES menu option the time in this option should be set to 00:00 HR:MN, otherwise the two features will interact. This will cause the timer to enact a sampling cycle rather than the set number of contact closures if the time interval occurs before the # OF CONTACT CLOSURES..

### Unequal Intervals

Allows the operator to input desired time between samples in an hours:minutes format where the time between samples can vary. The operator is allowed a maximum of 12 different time periods between samples. If more than 12 samples were selected in NUMBER OF SAMPLES menu option the remaining time periods will repeat time period #12.

If only 5 samples were selected in NUMBER OF SAMPLES only 5 time periods will appear in the selection menu. The display appears as follows:

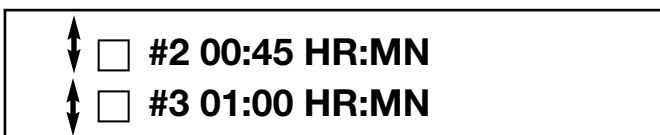
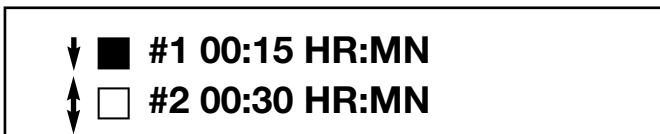

**HINT:** The display is only 2 lines, so you will only see 2 choices at one time. Remember the arrow in the first column indicates whether there are choices above or below the ones you are viewing.

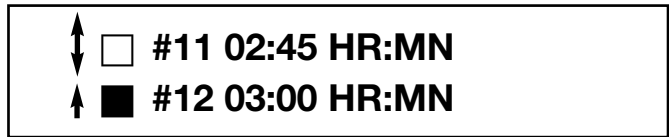

Once you have made your selections and pressed enter the display changes to read:



Use the down arrow key to navigate and select # OF CONTACT CLOSURES and press ENTER. The display changes to read:



### # OF CONTACT CLOSURES

This menu option will not be visible if you selected REMOTE & DELAYED START in the PROGRAM START option and selected the MAINTAINED CONTACT menu option. The system will be started by a single contact closure. The system will take a sample after the specified number of contact closures occurs.

The number of contact closures available is 0-9999. The default is 0.

Once you have made your selections and pressed enter the display changes to read:

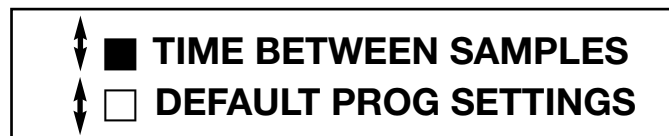

Use the down arrow key to navigate and select DEFAULT PROG SETTINGS and press ENTER.

**DEFAULT PROGRAM SETTINGS**

Allows to the operator to return the program being edited to its factory default settings. This only affects the program being edited. The other sampling programs are unaffected. Upon selecting this menu option and pressing ENTER, the display will change to:



The default selection will not reset the program settings. You must use the up arrow to select "RESET PROGRAM SETTINGS" and press ENTER. Once the ENTER key has been pressed, the display will change to:



**HINT:** If you have returned a program to its default settings, there is no need to save it.

**SAVE PROGRAM**

Allows the operator to save an edited program under one of the five program numbers.

The program being edited does not have to be saved under the program number you are editing.

If you are editing program #1, this edited program could be saved as program #5. You will be overwriting whatever program was there. Factory default programs can be restored, modified programs cannot be restored once over written.

Use the down arrow key to navigate and select SAVE PROGRAMS and press ENTER. The display will change to:

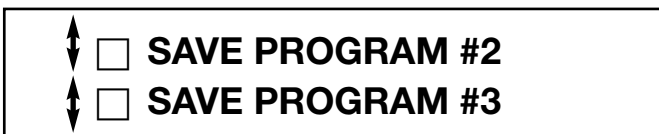

**HINT:** The display is only 2 lines, so you will only see 2 choices at one time. Remember the arrow in the first column indicates whether there are choices above or below the ones you are viewing.

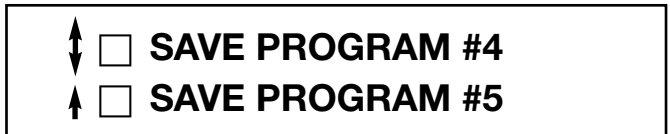

Once you have selected the program number under which the edited program will be saved and pressed ENTER. The display will return you to the program selection screen as shown below.

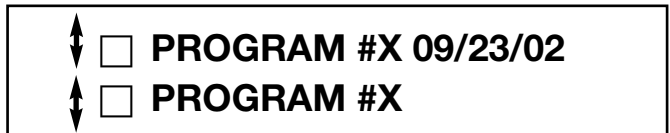

The LCD display will show you the program number you have saved the edited program under with a date at the far right of the screen. This date indicates that the program is an edited or modified program and the date it was saved. Programs using factory supplied defaults will not display a date to the right of the program number. In this way you can differentiate between a factory program and an edited one.

**HINT:** If you attempt to exit the VIEW/EDIT PROGRAMS menu without saving the program the following display screen will appear.



This is to confirm your choices and prevent accidental loss of desired changes to a program.

**HINT:** Edited programs can only be run once they are saved. If you do not save the edited program, it cannot be run and your edits will be lost.

**HINT:** To exit the menu and return to a system ready prompt use the cancel key.

## HOT KEYS

Three of the VIEW/EDIT PROGRAMS menu options are also accessible via "Hot Keys" located on the control console keypad. The keys are round, blue in color and labeled SAMP. VOL., TIME, and DELAY START. These keys allow the operator to access the sample volume, time between samples and delay starting time for the program currently selected to run without going through the menu.

**HINT:** To save the program setting you have just modified using the HOT KEYS you must save the program or your change will be lost.

## CALIBRATING THE SYSTEM

### GENERAL

The Composite Samplers' non-volatile memory contains flow data related to sample volume flow per Pump Head revolution versus sample lift height. This information is used to calculate the correct sample volume being taken by the system at a specific lift height. Due to the number of variables and variations possible with use of the Composite Sampler in the field, the stated accuracy of the unit is achieved only when the unit is calibrated at the field site after setup of the sampler as it will be used.

### MINIMUM SAMPLE SIZE

The stated accuracy of the sample volume being taken is predicated on a minimum sample size versus the tubing size used to take the sample.

For L/S® 15 size tubing the minimum sample size for stated calibrated sample accuracy is 167 milliliters.

For L/S® 24 size tubing the minimum sample size for stated calibrated sample accuracy is 270 milliliters.

### REQUIRED EQUIPMENT

To calibrate the Composite Sampler you will need a graduated cylinder with a minimum volume of 250ml for use with L/S® 15 tubing or 500 mL for use with L/S® 24 tubing. The graduated cylinder is not supplied with the sampler system and is the users' responsibility to provide one. See the ACCESSORIES section for recommended graduated cylinders.

## CALIBRATION PROCEDURE

1. Setup the Composite Sampler on site as it will be used for sampling.
2. Verify that the global settings for lift height and tubing length have been entered.
3. Disconnect the sample hose from the sample reservoir quick disconnect fitting.
4. Have the graduated cylinder ready.
5. Press the CAL key.

The display will change to read:

**START TUBE CALIBRATION  
USING FACTORY CAL**

6. Press the ENTER key and hold the sample hose to the graduated cylinder.
7. The system will first purge the sample intake line and then take a calibration volume. When the sample has completed taking a calibration volume, the display will change to read:

**ENTER MEASURED VOLUME**  
\_ \_ \_ . \_ **ML (1-999.9)**

8. Read the volume from the graduated cylinder and enter the volume measured on the numeric keypad and press the ENTER key. EXAMPLE: If the volume was 10.5 ml enter 105 and press ENTER. If the measured volume was 267.5 ml enter 2675 and press ENTER.
9. The system will then return to a system ready prompt on the LCD display.

**SAMPLER SYSTEM READY**  
**HH:MM:SS MM/DD/YYYY**

## PREVIOUS CALIBRATIONS

If the Composite Sampler System was previously calibrated on another site, the recommendation is to restore the factory calibration prior to calibrating the system at another site. To restore the factory calibration press the CAL key. The display will change to read:

↓ ■ **START TUBE CALIBRATION**  
 ↑ □ **USING FACTORY CAL**

Use the down arrow key to navigate and select RESTORE FACTORY CAL and press ENTER. The Display will change to request a confirmation of requested action and will read as shown below.

↓ □ **RESTORE FACTORY CAL**  
 ↑ ■ **DON'T RESTORE CAL**

Navigate using the up arrow to select RESTORE FACTORY CAL and press ENTER.

The display will change to read as shown at the beginning of the calibration procedure.

## CYCLING THE SYSTEM

The operational readiness of the system and sample lines can be checked prior to starting the sampling program. The operator can perform this check by:

1. Disconnecting the sample line from the sample reservoir at the quick disconnect fitting on the reservoir cap. Point the end of the sample line away from the unit.
2. Press CYCLE TEST key.
3. The unit will go through a through a purge cycle, a single rinse cycle if one or more are programmed, and draw a single sample of the volume programmed.
4. Reconnect the sample line to the sample reservoir cap once you have completed this check.

## MAINTENANCE

**WARNING:** *Disconnect the Composite Sample from any external power source before cleaning. A shock hazard exists when using water on powered equipment.*



### CLEANING:

Keep the exterior housing and sample reservoir clean by using a mild detergent and soap solution. Never immerse the unit in water or use excessive fluid when cleaning the system. Dry the cleaned parts before restoring external power.

### SAMPLE RESERVOIR VENTS

The sample reservoir cap contains two breather vents allowing the reservoir to be filled with fluid, while expelling air. These vents can become clogged by particulate matter present in the fluid samples taken at various sites.

To clean the vents apply a vacuum source to the inside bore of the vent to remove any contaminants or foreign matter. If cleaning is unsuccessful in unclogging the vents, they will have to be replaced.

Refer to USER REPLACEMENT PARTS for the part numbers of all user replacement parts.

### TUBING

The tubing will occasionally have to be replaced due to wear at the Pump Head and fouling.

The routing of the tubing is important, since it will change the performance of the product if **not** performed correctly.

The correct routing of the tubing is as follows:

1. From the Sample Inlet bulkhead connector to the bottom of the Flow Detector. A tubing length of 18" is required.
2. From the top of the Flow Detector through the pump to the Sample Reservoir. A tubing length of 17.63" is required.

# TROUBLESHOOTING

## GENERAL

### ERROR STATUS/MESSAGES AND SOLUTIONS

#### Message Types

Various messages on the system's LCD display alert the operator to the condition of or possible problems with the system. Some can be addressed by the operator, while other problems require factory servicing or assistance. Most problems that occur can be corrected by the operator on site. The following is a listing of messages their meaning and possible remedies if applicable:

#### Display Reads

#### Descriptions and Remedies

<b>BAD GLOBAL SETUP USING DEFAULTS</b>	Global setup data from EEPROM corrupted, reset GLOBAL SETTINGS to their defaults.
<b>BAD USER CAL DATA USING DEFAULTS</b>	User field cal Data from EEPROM corrupted, reset to factory cal.
<b>REAL TIME CLOCK ERROR CHECK BATTERY</b>	Run data in RTC RAM corrupted, program running status lost. Charge or replace battery as necessary.
<b>BATTERY FULLY CHARGED</b>	During battery check, voltage under load $\geq$ 12.5V.
<b>BATTERY LOW CHARGING IS RECOMMENDED</b>	During battery check, voltage under load < 12.5V. Strongly recommend you charge the battery. You may not have enough power to run a complete sampling program sequence. Charge the battery.
<b>BATTERY IS VERY LOW MUST CHARGE BATTERY!</b>	During battery check, voltage under load < 11.9V. You must charge the battery! Damage to unit can result if run in a discharged state.
<b>CAN'T CHARGE BATTERY MUST REPLACE BATTERY</b>	Battery was in trickle charge state for over 4 hours (< 10.5V). Replace the battery.
<b>ERROR: NO BATTERY MUST REPLACE BATTERY</b>	Detected battery voltage over 16V. Check battery connections. If connected, replace the battery. Contact factory for further assistance if needed.
<b>BAD FLASH CHECKSUM SERVICE REQUIRED</b>	Bad program checksum in flash. Operation of unit is disabled. Internal system problem. Contact factory for assistance.
<b>NO MOTOR FEEDBACK SERVICE REQUIRED</b>	No encoder pulses detected. Internal system problem, contact the factory for assistance.
<b>MOTOR OVER SPEED SERVICE REQUIRED</b>	Motor running too fast. If any servicing of the motor took place recently, the motor leads may have been reversed. Check that the polarity of the motor leads matches the coding next to the terminal. Red lead to terminal marked red, black to black. Contact the factory for assistance if problem cannot be corrected.
<b>MOTOR OVERLOAD CHECK TUBING</b>	Motor is stalled. Motor current is at maximum and battery is not low. Shutoff the Composite Sampler. Remove tubing from pump. Verify that the correct tubing size and formulation listed by this manual is being used. Replace tubing in pump. Contact the factory for assistance if problem cannot be corrected.
<b>SAMPLE RESERVOIR FULL MUST EMPTY RESERVOIR</b>	Sample reservoir is full. Reservoir must be emptied before you can continue. Empty reservoir, then press CANCEL to clear error message.
<b>ERROR: CHECK FLOW SENSOR</b>	The flow sensor still shows continuity indicating the presence of fluid. Check flow sensor for fluid, by disconnecting upper tubing connection, then lower connection. If fluid present, clear flow sensor of all fluid. Press CANCEL. If message persists contact factory for assistance.
<b>NO FLOW DETECTED SERVICE REQUIRED</b>	The flow sensor has not detected any fluid flow through the tubing. The sample inlet line may have become obstructed. Verify that the sample inlet line is not blocked or obstructed, and check for a hole in the tubing. Contact the factory for assistance.

# USER REPLACEMENT PARTS/SERVICING

## INTERNAL BATTERY REPLACEMENT

**TOOLS REQUIRED:**

- #2 Phillips screwdriver
- 5/16" Nut driver or Spin Tight
- 13/16" open or closed end wrench
- Torque wrench and applicable sockets and blades
- Paper or cloth toweling
- 2 blocks of wood 1.5" thick x 2-4" wide x 8" long

1. Lay the unit flat with the "E/S COMPOSITE SAMPLER" label on the front facing up.
2. Open the exterior housing access to the control console.
3. Disconnect and remove the sample intake line from the bulkhead connector sample line inlet to the Flow detector. Disconnect and remove the tubing from the Flow detector which is routed through the pump to the sample reservoir.

**NOTE:** Use the toweling to catch or absorb any liquid that may be present when disconnecting the tubing fittings.

4. Disconnect the sample reservoir overflow sensor cable located at the top of the reservoir cap.
5. Unlatch the strap holding the sample reservoir and remove reservoir.
6. Using the phillips screwdriver remove the (4) four screws holding the control console to the exterior housing.

**DO NOT ATTEMPT TO REMOVE THE CONTROL CONSOLE.**

7. Slide the control console 3 to 4 inches to the left. Using the 13/16" wrench, unscrew the nut holding the REMOTE CONTACT CLOSURE connector to the exterior housing, while holding the connector from the inside of the exterior housing.
8. Push the connector into the exterior housing until it falls free of the housing. Retained the tethered cap for assembly of the unit.

**CAUTION:**



**Control console is heavy, weighing almost 20 pounds. To prevent injury to yourself and damage to the unit do not drop the console and be prepared for its weight.**

9. Holding the control console firmly, lift the console free of the unit and place the control console on its side on the 2 blocks of wood to prevent damage to the sample reservoir overflow sensor cable.
10. Using the 5/16" nut driver, loosen and remove the (4) keps nuts holding the battery retaining bracket in place.
11. Remove the battery retaining bracket by lifting it up.
12. Slide the battery to the right and disconnect the battery terminals and remove battery.

**DANGER:**



**NEVER short or connect the battery terminals together. Shorting of the battery terminals causes rapid internal heating of the battery resulting in the explosion of the battery and severe injury or the death of the operator. Even a battery that is fully discharged can exhibit this potential.**

**CAUTION:**



**If the battery connections are reversed, damage to the unit may occur. The battery terminals are color coded. Connect the black wire to the black terminal, and the red wire to the red terminal.**

13. Remove the quick disconnect terminals supplied with the replacement battery and place them over the terminals of the old battery.
14. Reverse the process to install the battery. Connect the RED wire to the battery terminal marked + (positive). Connect the BLACK wire to the terminal marked - (negative).
15. Torque the battery bracket retaining nuts to 6-7 in lbs.
16. Torque the REMOTE CONTACT CLOSURE connector nut to 5-6 in lbs.
17. Fully charge the unit before using for the first time. Damage to the internal battery can result if the battery is fully discharged and operation of the unit is attempted.

**DANGER:**



**DO NOT BURN OR INCINERATE THE BATTERY. THE BATTERY MAY EXPLODE CAUSING SEVERE INJURY OR DEATH OF PERSONNEL IN THE AREA. (Dispose of the old battery at your local recycling center or contact the battery manufacturer.)**

## USER REPLACEMENT PARTS

77200-07	AC/DC Universal Power Supply/Converter 100-240V AC
77500-03	Fuse, Automotive Power Adapter or Auxiliary Power Pack
07571-55	Battery 12V 7.2AH
06360-82	Sample Line Tubing Connector, Quick Connect
06361-46	Bulkhead Connector, Sample Line Quick Connect
31305-10	Tubing Connector, Flow Detection Module, Quick Connect (pkg. of 10)
06361-63	Tubing Connector, RA, Reservoir, Quick Connect
06032-20	Reservoir w/ blank cap, 9 liter
07580-70	Cap Assembly, Sample Reservoir
07580-75	Vent, Reservoir Cap, package of 2
96400-24	Tubing, Plat. Silicone Size 24, 25' package

## ACCESSORIES

06138-10	Graduated Cylinder, PMP, 60 mL, calibrated TC/TD
06138-40	Graduated Cylinder, PMP, 250 mL, calibrated TC/TD
06138-60	Graduated Cylinder, PMP, 500 mL, calibrated TC/TD
06456-10	Tubing Connector, 3/16 in (L/S® 15 size tubing) barbed
06456-20	Tubing Connector, 1/4 in (L/S® 24 size tubing) barbed
07570-04	Tubing Weight, Stainless Steel, flow-through fits L/S® 15 and 24 size tubing
78226-82	Tubing Weight, PTFE, flow-through fits L/S® 15 and 24 size tubing
07571-50	Automotive Power Adapter, Current Limited
07571-52	Auxiliary Power Pack w/Charger 115V AC
07571-54	Auxiliary Power Pack w/Charger 230V AC
07580-50	Deluxe Carrying Strap
07580-60	Cable Assembly 25', Remote Contact Closure
07580-65	Adapter Assembly RS-232

## SPECIFICATIONS

### Output:

Speed:	600 rpm with EASY-LOAD Pump Head 300 rpm with PTFE Pump Head
Maximum continuous torque:	30-in oz. (212 N•mm)
Speed regulation:	+/- 1 RPM

### Input:

Supply voltage limits:	
115V AC	90V AC to 130V AC, 47-63 Hz
230V AC	180V AC to 260V AC, 47-63 Hz
12V DC	11-18V DC
Nominal Current:	
115V AC	120 mA
230V AC	60 mA
12V DC	2.0 A
Installation category:	Category II per IEC 664 (local level appliances, portable equipment, etc.)
Remote input:	START

### Display:

24-character x 2 line backlit  
capable LCD

### Number of Pump Heads:

1

### Suction Lift:

25 Feet (8.3meters)

### Sampling Accuracy:

With field calibration: +/-5% of sample volume

### Min. Sample Volume for Accuracy w/Calibration:

L/S® 15	170 mL
L/S® 24	270 mL
PTFE 2mm ID	16 mL
PTFE 4mm ID	5 mL

### Construction:

Dimensions:	11.0 in x 10.25 in x 16.0 in (27.94 cm x 26.04 cm x 40.64 cm)
Weight	23.0 lbs. (10.43kg)

### Environment:

Operating Temperature:	1°C to 50°C (34°F to 122°F)
Storage Temperature:	-20°C to 65°C (-4°F to 149°F)
Humidity (non-condensing):	10% to 90%
Altitude:	Less than 2000 m (6500 ft.)
Pollution Degree:	Pollution degree 3 per IEC 664
Chemical resistance:	All materials withstand standard cleaning solvents. Materials used in the construction are: A polyester label, HDPE exterior housing with anodized aluminum valance and chromate and painted aluminum control console.
Environmental protection:	Withstands wind driven rain in an outdoor environment (IEC-529 IP56)

### Compliance:

100-240V AC Universal  
Power Supply AC/DC  
Converter is UL listed  
CSA and CE approved.  
Regulatory agency  
specifications not  
applicable to the  
balance of the unit due to  
low voltage.  
EN61010-1/A2: 1995  
(EU Low Voltage Directive)  
EN61326-1/A1: 1998  
(EU EMC Directive)

## **WARRANTY**

***Use only MASTERFLEX tubing with MASTERFLEX tubing pumps to ensure optimum performance. Use of other tubing may void applicable warranty.***

The Manufacturer warrants this product to be free from significant deviations from published specifications. If repair or adjustment is necessary within the warranty period, the problem will be corrected at no charge if it is not due to misuse or abuse on your part, as determined by the Manufacturer. Repair costs outside the warranty period, or those resulting from product misuse or abuse, may be invoiced to you.

***The warranty period for this product is two (2) years from the date of purchase.***

## **PRODUCT RETURN**

To limit charges and delays, contact the seller or Manufacturer for authorization and shipping instructions before returning the product, either within or outside the warranty period. When returning the product, please state the reason for the return. For your protection, pack the product carefully and insure it against possible damage or loss. Any damages resulting from improper packaging are your responsibility.

## **TECHNICAL ASSISTANCE**

If you have any questions about the use of this product, contact the Manufacturer or authorized seller. We reserve the right to make improvements in design, construction and appearance of our products without notice.

# ACCESSORY OPERATING INSTRUCTIONS

## AUTOMOTIVE POWER ADAPTER

Model No.

**07571-50**

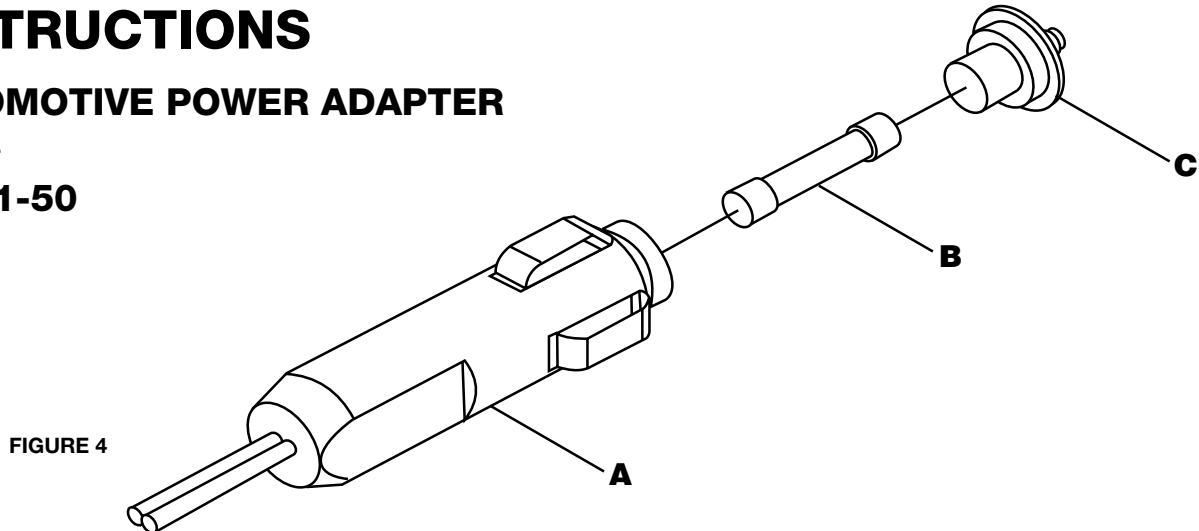

## SAFETY PRECAUTIONS

**WARNING:** *PRODUCT USE LIMITATION This product is not designed for, nor intended for use in, patient-connected applications, including, but not limited to, medical and dental use and, accordingly, has not been submitted for FDA approval.*



## INTRODUCTION AND GENERAL DESCRIPTION

The MASTERFLEX Automotive Power Adapter is intended to provide 12 V DC power to the Portable Sampling Drives 07571-00 and 07571-05 from an automotive electrical system through the cigarette lighter present in most foreign and domestic vehicles.

The Automotive Power Adapter is current limited by the customer replaceable fuse. The fuse is a fast-acting type F (3AG) rated @ 5.0A 250V.

### CHARGING THE INTERNAL BATTERY

The unit cannot be recharged from a 12V DC battery. The unit can be run from a 12V battery, but charging the internal battery requires a minimum DC input voltage of 13.8 volts. The maximum DC input voltage allowed is 16.0 volts. The polarity of the 2.5 mm coaxial jack required for input to the EXTERNAL POWER INPUT is as follows:

Center – Positive  
Sleeve – Negative

### FUSE REPLACEMENT

1. Disconnect the adapter cable from the cigarette lighter in the vehicle. Disconnect the other end from the Portable Sampling Drive.
2. To access and replace the fuse, unscrew the ADAPTER TIP (C) from the ADAPTER BODY (A), the FUSE (B) will slide out and may be replaced. The COLE-PARMER fuse replacement part number is 77500-03.

**WARNING:** *Replace the fuse only with the same type and rating as the original. Use of a fuse type of rating other than specified can result in damage to equipment or injury to the operator.*



3. To install, reverse the replacement process.

# OPERATING INSTRUCTIONS

## AUXILIARY POWER-PAK

Model No.

**07571-52 & 07571-54**

## SAFETY PRECAUTIONS

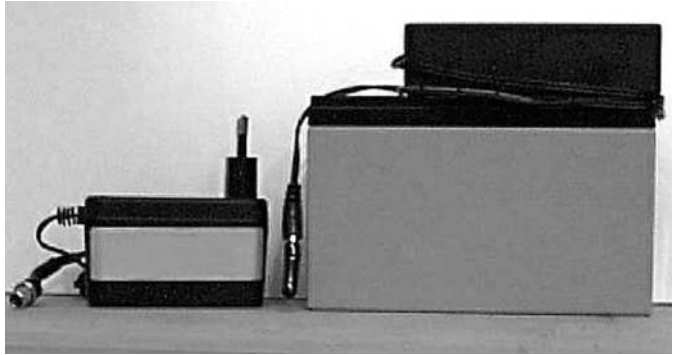

**WARNING:**

**PRODUCT USE LIMITATION**

*This product is not designed for, nor intended for use in, patient-connected applications, including, but not limited to, medical and dental use, and, accordingly, has not been submitted for FDA approval.*



**DANGERS:**

**NEVER** short the power pack coaxial connector or battery terminals. Shorting of the coaxial connector or terminals causes rapid internal heating of the battery which can result in the explosion of the battery causing severe injury or death to the operator.



The charger for the Auxiliary Power Pack Kit is rated for **INDOOR USE ONLY**. **DO NOT** use the charger in an outdoor environment to charge the battery. Electrical shock, severe injury and/or death is possible if this warning is ignored.

**DO NOT BURN OR INCINERATE THE BATTERY, THE BATTERY MAY EXPLODE CAUSING SEVERE INJURY OR DEATH OF PERSONNEL IN THE AREA.** (Dispose of the old battery by recycling.)

**WARNING:**

**DO NOT** use a battery charger other than the one supplied with the power pack to charge the battery. If this warning is ignored, damage to the unit and personal injury can result.



**WARNING:**

**NEVER** use a fuse of a different type or rating than that supplied with the unit. Use of a fuse of a different type or rating can result in damage to the unit and personal injury if this warning is ignored.



**CAUTIONS:**

Fully charge the unit (8 to 12 hours) before using for the first time. Damage to the battery pack can result if the battery is fully discharged and operation of the unit is attempted.



The Power Pack (battery assembly) is continually powered. To prevent accidental shorting of the coaxial plug, a protective cap is supplied with the unit. The protective cap should be installed over the coaxial plug when the Auxiliary Power Pack is not in use. If this warning is ignored, improper operation of this unit can occur.

Excessive charging of the battery will result in possible damage to the unit and shortening of its useful life. Do not charge battery for more than 24 hours.

Immersion or submersion of the unit will result in improper operation and possible damage to the unit.

## INTRODUCTION AND GENERAL DESCRIPTION

The MASTERFLEX E/S Auxiliary Power Pack Kit is intended to provide supplemental 12V DC power to the Portable Sampling Drives 07571-00 and 07571-05 in the field.

The MASTERFLEX Auxiliary Power Pack Kit consists of a fused, current-limited, rechargeable, sealed lead-acid battery with a current limited charger and carrying pouch. The Power Pack plugs directly into the charger for recharging or directly into the “EXTERNAL POWER INPUT” port of the Portable Sampler to provide supplemental power for extended operation of the Portable Sampling Drive.

## OPERATING DIRECTIONS TO CHARGE THE AUXILIARY POWER PACK

**CAUTIONS:**



*Fully charge the unit (8 to 12 hours) before using for the first time. Damage to the battery pack can result if the battery is fully discharged and operation of the unit is attempted.*

*The Power Pack (battery assembly) is continually powered. To prevent accidental shorting of the coaxial plug, a protective cap is supplied with the unit. The protective cap should be installed over the coaxial plug when the Auxiliary Power Pack is not in use. If this warning is ignored, improper operation of this unit can occur.*

**WARNING:**



*DO NOT use a battery charger other than the one supplied with the power pack to charge the battery. If warning is ignored, damage to the unit and personal injury can result.*

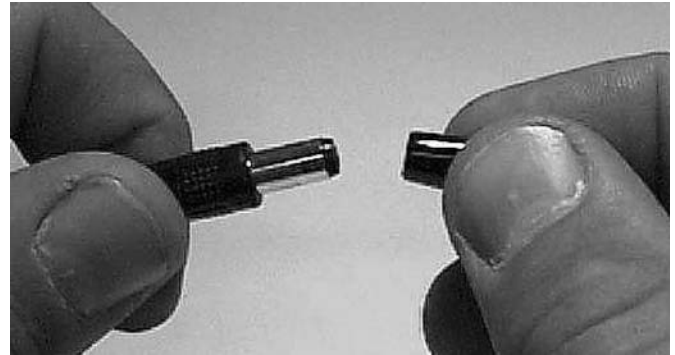

- A. Remove the protective cap from the coaxial connector of the battery portion of the Auxiliary Power Pack and mate it to the receptacle on the charger portion.
- B. Connect the charger to an AC receptacle consistent with the voltage listed on the charger.
- C. Allow the unit to charge for 8–12 hours.
- D. Disconnect charger from AC receptacle.
- E. Disconnect battery from charger.
- F. Reinstall insulating cap over coaxial plug.

**CAUTION:**



*Excessive charging of the battery will result in possible damage to the unit and shortening of its useful life. Do not charge battery for more than 24 hours.*

## USING THE AUXILIARY POWER PACK TO RUN THE PORTABLE SAMPLER

- A. Remove the protective cap from the coaxial plug of the power pack (battery) and install connector into the EXTERNAL POWER INPUT of the drive.
- B. Toggle the EXTERNAL/BATTERY switch to the EXTERNAL position.
- C. Toggle the RUN/CHARGE switch to the RUN position.
- D. Adjust drive controls for pumping direction and speed as desired.

## MAINTENANCE

**CAUTION:** *Immersion or submersion of the unit will result in improper operation and possible damage to the unit.*



### CLEANING

Clean exterior and interior surfaces of the unit using a dry or damp cloth with mild detergent. Never immerse nor use excess fluid.

**WARNING:** *NEVER use a fuse of a different type or rating than that supplied with the unit. Use of a fuse of a different type or rating can result in damage to the unit and personal injury if this warning is ignored.*



### BATTERY ASSEMBLY FUSE REPLACEMENT

- A. Remove the four screws securing the cover to the unit.
- B. The fuse is located in an in-line fuse holder.
- C. Grasp the fuse holder at both ends, push together, and twist one-half of the fuse holder 90°.
- D. Remove and replace the exposed fuse with a fast-acting 3AG 5A fuse, MASTERFLEX #77500-03.
- E. Reverse process to reassemble the Battery Assembly.

### CHARGING UNIT

The charging unit is sealed and has no serviceable internal parts or components.

## BATTERY

The battery is spill-proof and sealed, has no serviceable internal parts or components and is constructed for years of useful service when maintained properly.

**CAUTION:** *Fully charge the unit (8 to 12 hours) before using for the first time. Damage to the battery pack can result if the battery is fully discharged and operation of the unit is attempted.*



- A. Fully charge the unit before first use.
- B. Store unit at room temperature if possible.
- C. Always store the unit in a fully charged condition.
- D. The battery (Power Pack) will partially self-discharge over time. The rate of self-discharge increases with temperature. It is recommended that the unit be run for at least 2 hours every six months and then recharged overnight. This will preserve the potential life of the internal battery to its fullest extent.
- E. Do not leave the unit on charge for more than 24 hours. Unnecessary extended charging will cause internal heating and potential premature failure of the battery. The battery will fully charge in 8–12 hours from a fully discharged state.

# OPERATING INSTRUCTIONS

## REMOTE CONTACT CLOSURE ADAPTER CABLE

Model No.

**07580-60**

## INTRODUCTION

This adapter is used with the model 7580-00 Composite Sampler. It allows the connection of external devices or instruments capable of supplying a dry contact closure for the remote activation of the Composite Sampler.

### CONNECTION:

Strip the end of the wires and connect the device to the red and black lead wire end of the cable. Install the end with the connector to the REMOTE CONTACT CLOSURE receptacle on the right side of the exterior housing. Tighten the connecting ring <sup>1</sup>/<sub>4</sub> turn.

# OPERATING INSTRUCTIONS

## RS-232 ADAPTER

Model No.

**07580-65**

## INTRODUCTION

This adapter is used with the model 07580-00 E/S™ Composite Sampler. It allows data to be transferred from the control console's RS-232 port to a RS-232 computer serial port. The Composite Sampler and this adapter do not support bi-directional communications.

The computer must have an available RS-232 serial communications port, capable of being set at 19,200 baud. The computer must also have appropriate software such as WINDOWS TERMINAL or WINDOWS 9X HYPERTERMINAL.

Other versions of Windows may have similar programs. Many other RS-232 programs can also be used. The data is transferred as common ASCII text. By using the Windows copy and paste functions, you can transfer data into a spreadsheet or word processing program.

## CONNECTING THE RS-232 ADAPTER TO YOUR COMPUTER

The RS-232 adapter is powered by the computer serial port, and requires no other power source. Connect the DB9 connector from the adapter to the available serial port. If your serial port has a DB25 connector, you will have to obtain a 25-to-9-pin adapter from your computer supply source. If an extension cable is used, pins 2, 3, and 5 (for the 9-pin connector) or pins 2, 3, and 7 (for the 25-pin connector) should be wired straight through.

## WINDOWS 3.1 AND WINDOWS 3.11 TERMINAL SET-UP

Due to variations in WINDOWS programs, only general instructions are given here. Refer to your WINDOWS documentation for complete information.

From the "PROGRAM MANAGER" click on "ACCESSORIES" and then "TERMINAL".

When Terminal has finished loading, click on "SETTINGS", "COMMUNICATIONS", then set the following controls:

<u>Baud Rate</u>	<u>Data Bits</u>	<u>Parity</u>	<u>Flow control</u>	<u>Stop bits</u>
19,200	8	None	Hardware	1

Connection: Choose COM1 or COM2 depending on which the adapter is connected to.

Click on OK.

Click on "Transfers" and select "Receive Text File."

Enter a descriptive file name and click on OK.

When you exit TERMINAL, it will ask if you want to save your settings. Click on YES and enter a descriptive name, such as SAMPLER. The next time you use TERMINAL, click on FILE, OPEN, and selecting the TERMINAL program will automatically be configured as above.

## WINDOWS 9X AND WINDOWS NT HYPERTERMINAL SET-UP

Due to variations in WINDOWS and HYPERTERMINAL programs, only general instructions are given here. Refer to your WINDOWS documentation for complete information.

From the Desktop, click on "Start". Then select "Programs," "Accessories," "HYPERTERMINAL". Either a "CONNECTION DESCRIPTION" or "Hyperterm" folder will pop up. If the folder pops up, select "HYPERTERM.EXE". In either case the "CONNECTION DESCRIPTION" will then pop up.

Enter a descriptive name, such as "SAMPLER," and then click OK. The "CONNECT TO" window pops up. Click on the selector arrow next to "CONNECT USING" and select "DIRECT TO COMX" based on which com port the adapter is connected to.

Click OK. A "PORT SETTINGS" window will pop up. Use the following PORT SETTINGS.

<u>Bits per Sec</u>	<u>Data Bits</u>	<u>Parity</u>	<u>Stop bits</u>	<u>Flow control</u>
19,200	8	None	1	Hardware

Click on OK. Click on "TRANSFER," then "CAPTURE TEXT". 

Enter a descriptive file name and click OK.

The next time you run HYPERTERMINAL, you may select SAMPLER.ht. The HYPERTERMINAL program will automatically be configured as above. Then, if the "CONNECTION DESCRIPTION" window pops up, just click on "CANCEL"

Press SETUP to exit.

## TRANSFERRING THE DATA LOG

Access the menu by pressing the MENU key. Select GLOBAL SETTINGS and press ENTER. Use the down arrow key to navigate; select the menu option LOG DATA and press ENTER.



The display will change to read:



Navigate and select PRINT DATA and press ENTER. The display will change to read:







**Cole-Parmer**

1-800-MASTERFLEX (627-8373) (U.S. and Canada only)

11 (847) 549-7600 (Outside U.S.)

(847) 549-7600 (Local)

[www.masterflex.com](http://www.masterflex.com)

[techinfo@coleparmer.com](mailto:techinfo@coleparmer.com)



---

Thermo Fisher Scientific  
1-800-637-3739 (U.S. and Canada only)

11 (847) 381-7050 (Outside U.S.)

(847) 381-7050 (Local)

[www.thermo.com](http://www.thermo.com)

[bar.barnant@thermofisher.com](mailto:bar.barnant@thermofisher.com)

